

Comax Series 125_{SP}

Protects from:



Air



Water



Light



Insects



Not an obstacle for disabled persons

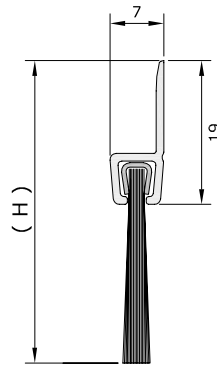
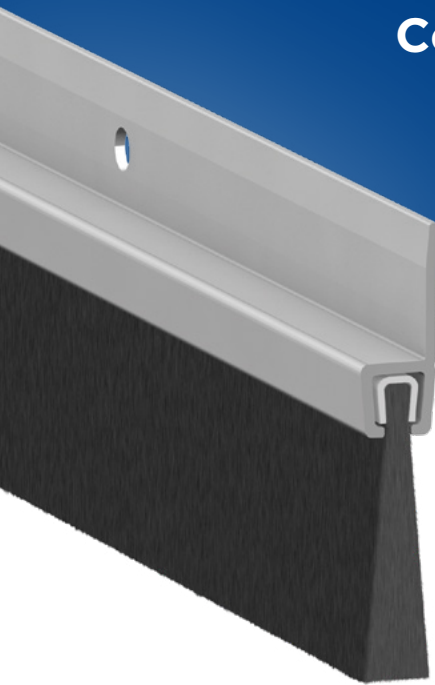

- **DIMENSIONS** 100 - 300
- **HEIGHT** 30 - 40 - 50 - 60
- **FEATURES** Fixed profile with gasket.
- **COMPONENTS** Extruded profiles in raw aluminium alloy 6060, brush gasket.
- **PACKAGING** 30 pcs box.

FASTENING SYSTEMS

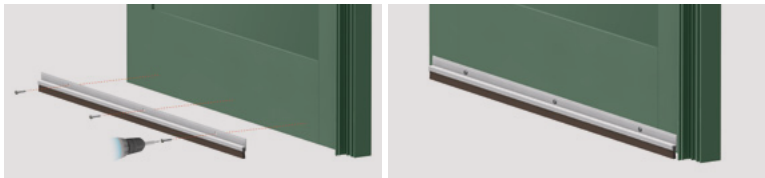

Screw

MAIN APPLICATIONS

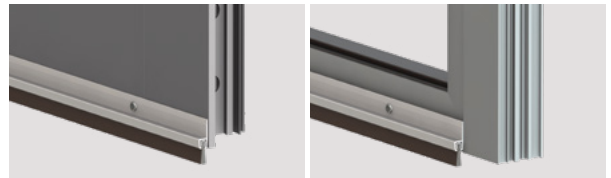

Iron door

Aluminium door

Comax Series 126_{SP}

Protects from:



Air



Water



Light



Insects



Not an obstacle for disabled persons

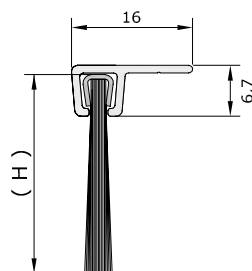
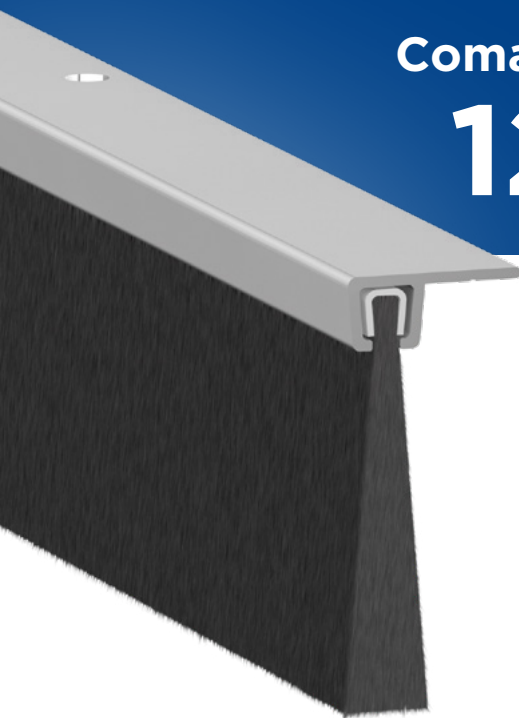

- **DIMENSIONS** 100 - 300
- **HEIGHT** 17 - 27 - 37
- **FEATURES** Fixed profile with gasket.
- **COMPONENTS** Extruded profiles in raw aluminium alloy 6060, brush gasket.
- **PACKAGING** 30 pcs box.

FASTENING SYSTEMS

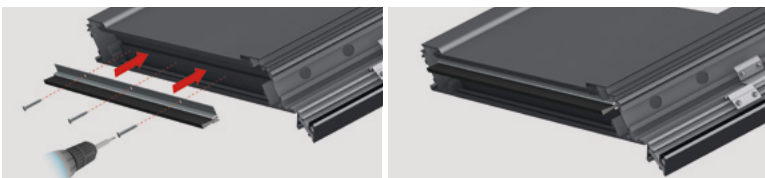

Screw

MAIN APPLICATIONS

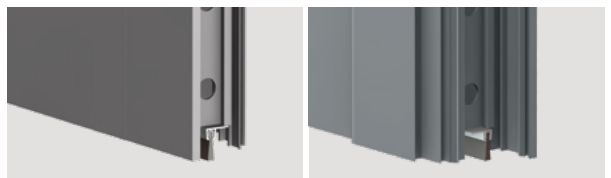

Iron door

Aluminium door